

**HUDEVAD**  
RADIATOR DESIGN

# SC HORIZONTAL



Datasheet

# INDEX

Specification ..... 2

Description ..... 3

Tapping overview ..... 4

Illustration ..... 5

Dimensions ..... 6

Output ..... 10

Options ..... 11

Angled and curved radiators ..... 11

Accessories ..... 12

# SPECIFICATION

## HOW TO SPECIFY AN ITEM

SC Horizontal item number example 221052442B

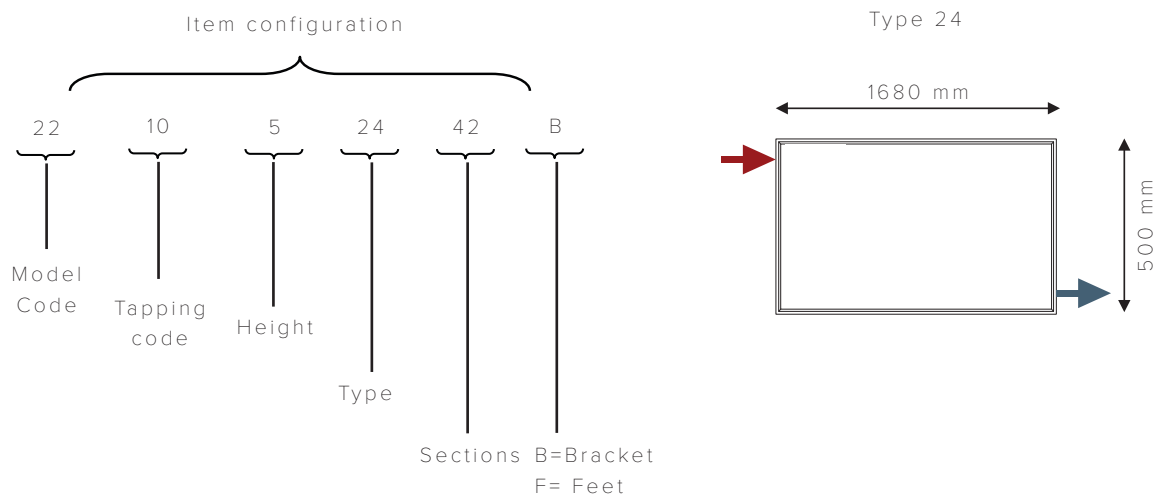

**Note**

Thermostat sensor head is not included in the product - should be ordered separately.

**Please indicate installation option:**

**B = Wall Bracket**

**F = Feet**

# DESCRIPTION

The Hudevad SC radiator is the perfect heating source for making a statement. The radiator has a high-end and timeless design that is highly customizable for the perfect fit in any environment. The radiator doesn't block the light, as its flat elements are designed for giving the room spaciousness and the impression of 'air'. The SC radiator is ideal for many applications due to its unique design that blends into the room architecture without stealing focus.

<b>Material</b>	Headers: Square steel tube 35 x 35 x 2.5 mm to EN 10305-5 Flat tube elements: Steel tube 70 x 11 x 1.9 mm to EN 10305-5
<b>Test pressure</b>	10 bar
<b>Max. operating pressure</b>	7.7 bar in accordance with EN 442
<b>Max. operating temp.</b>	95°C
<b>Surface treatment</b>	Pre-treatment by alkaline degreasing and a layer of zirconia as conversion coating. Powder coated in accordance with DIN 55900, EN 442.
<b>Element spacing</b>	40 and 60 mm
<b>Length</b>	400-3000 mm in increments of 80 and 120 mm, depending of element spacing.  Max. length, however, depends on height and weight
<b>Height</b>	400, 500, 600, 700 and 900 mm For height 300 mm please see SC Lowline
<b>Depth</b>	SCE, Type 14 or 16: 98 mm. SCD: Type 24 or 26: 160 mm
<b>Tappings</b>	1/2" standard
<b>Installation</b>	Wall or floor mounted. Air vents and plugs are included.
<b>Optional extras</b>	Fixed feet SF124
<b>Colour</b>	Powder coated in white RAL 9016. Gloss 70 Option: Painted in other standard RAL colours. For more information, please see the Hudevad Colour brochure at <a href="http://www.hudevad.com">www.hudevad.com</a>
<b>Note</b>	Type 14 = SCE, single, element spacing 40 mm Type 24 = SCD, double, element spacing 40 mm Type 16 = SCE, single, element spacing 60 mm Type 26 = SCD, double, element spacing 60 mm

# TAPPING OVERVIEW

Tapping code	Tapping type	Tapping possibilities
10	ABCD (4 tap)	
11	FF (6 tap)	
12	EE (6 tap)	
15	E/F No valve	

## TAPPING CODE 10 - ABCD - Side tapplings

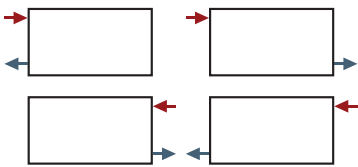

View from the front

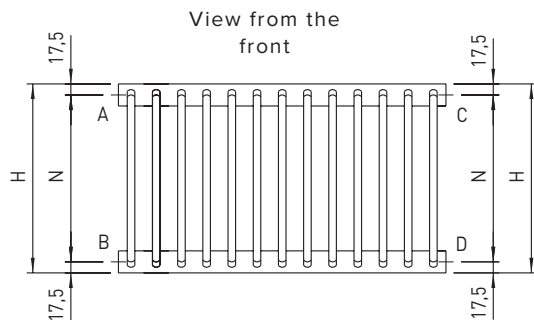

Centre distance N is calculated as: Radiator height (H)-35 mm

Note: We do not recommend same side connection on radiators above 1800 mm.

SCE, Type 14 or 16 profile

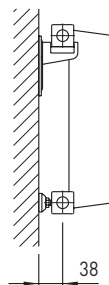

SCD, Type 24 or 26 profile

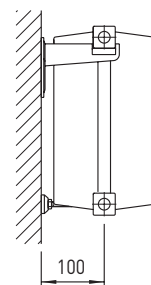

Drawing 4.1

TAPPING CODE 11, 12 AND 15 - EE / FF and E/F - Underside tapings

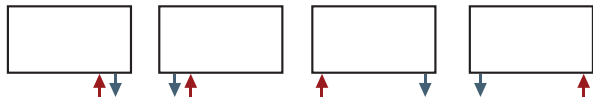

Drawing 5.1

View from the front

View from the front

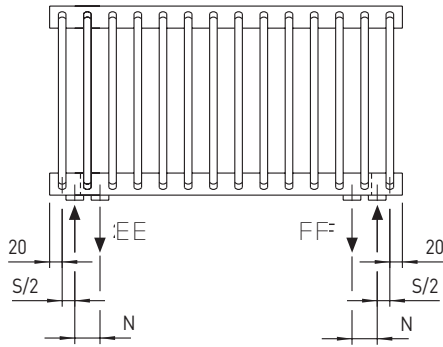

SCE, Type 14 or 16 profile

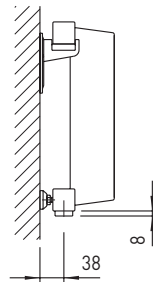

SCD, Type 24 or 26 profile

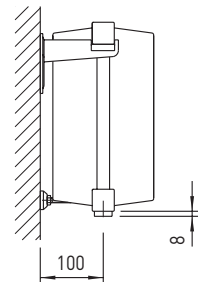

Centre distance N at tapping EE/FF corresponds to element spacing S

Note: Flow is always placed in the outer tapping. Radiator is factory fitted with a diverter plate between tapings to ensure optimum water flow.

# ILLUSTRATION

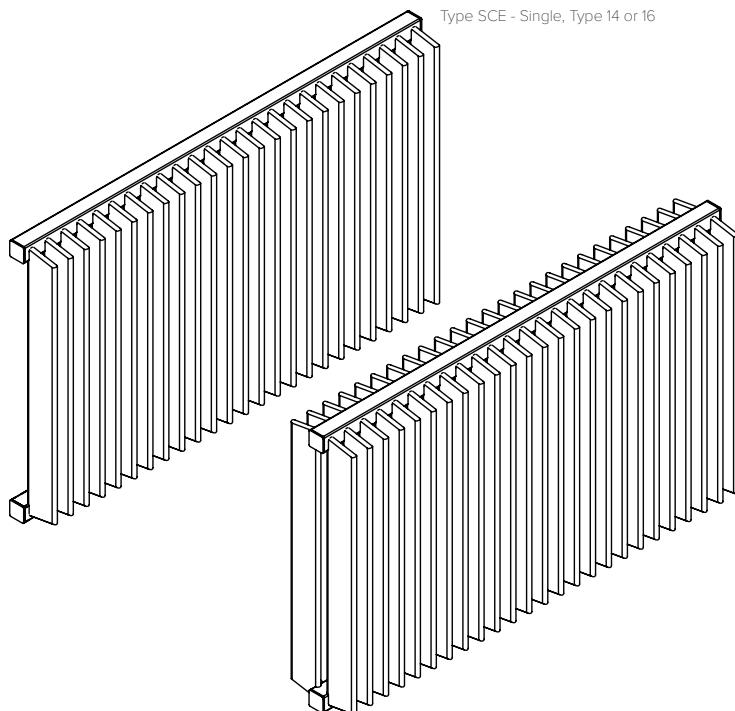

Drawing 5.2

Type SCD - double, Type 24 or 26

**HUDEVAD**  
RADIATOR DESIGN

Drawing 6.1

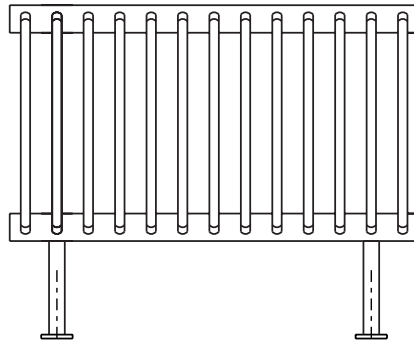

# DIMENSIONS

Radiator length is calculated as:  
 Element spacing  $S \times (\text{no. of elements} - 1) + 40 \text{ mm}$

No. of elements for a given radiator length is calculated as:  
 $(\text{radiator length } L - 40) / \text{element spacing } S + 1$

**Length table: see page 7**

Drawing 6.2

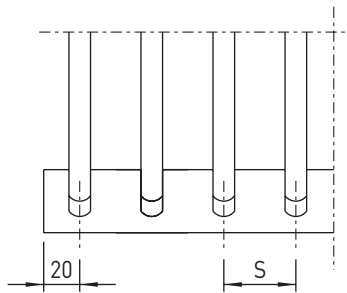

Element spacing  $S = 40 \text{ or } 60 \text{ mm}$

## LENGTH AND ELEMENT SPACING TABLE

Length mm	Element spacing, mm		Length mm	Element spacing, mm	
	40	60		40	60
400	10		1780		30
460		8	1840	46	
480	12		1900		32
560	14		1920	48	
580		10	2000	50	
640	16		2020		34
700		12	2080	52	
720	18		2140		36
800	20		2160	54	
820		14	2240	56	
880	22		2260		38
940		16	2320	58	
960	24		2380		40
1040	26		2400	60	
1060		18	2480	62	
1120	28		2500		42
1180		20	2560	64	
1200	30		2620		44
1280	32		2640	66	
1300		22	2720	68	
1360	34		2740		46
1420		24	2800	70	
1440	36		2860		48
1520	38		2880	72	
1540		26	2960	74	
1600	40		2980		50
1660		28			
1680	42				
1760	44				

**SC WALL MOUNTED**

Drawing 8.1

SC single (SCE), type 14 or 16 profile

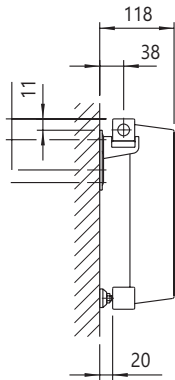

SC double (SCD), type 24 or 26 profile

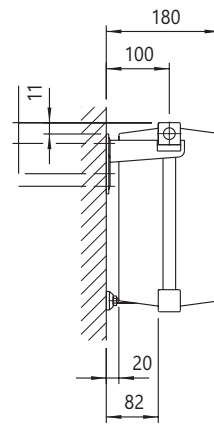

**Element spacing**

**No. of brackets and spacers**

**40 mm**

**60 mm**

	Elements	L, mm	Elements	L, mm
2/2	10-24	400-960	8-16	460-940
3/2	26-50	1040-2000	18-32	1060-1900
4/3	52-74	2080-2960	34-50	2020-2980

**SC FLOOR MOUNTED - FIXED FEET SF124**

Drawing 8.2

SF124 feet, profile

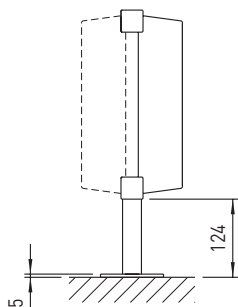

Foot plate for SF124 feet, top view

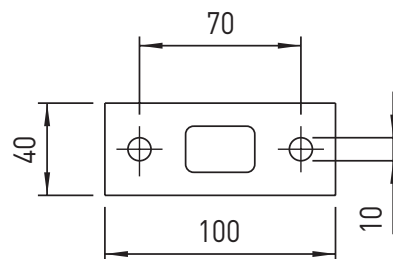



- Application** For use where wall mounting is not possible, e.g. in front of glazing
- Construction** 20 x 30 x 2 mm steel tube with foot plate of 5 mm steel  
Feet are welded onto the radiator
- Height** 124 mm from upper floor surface to lower edge of radiator
- Colour** Same as radiator
- Note** Limitations in radiator height, see table below

**VIEW FROM THE FRONT**

Drawing 9.1

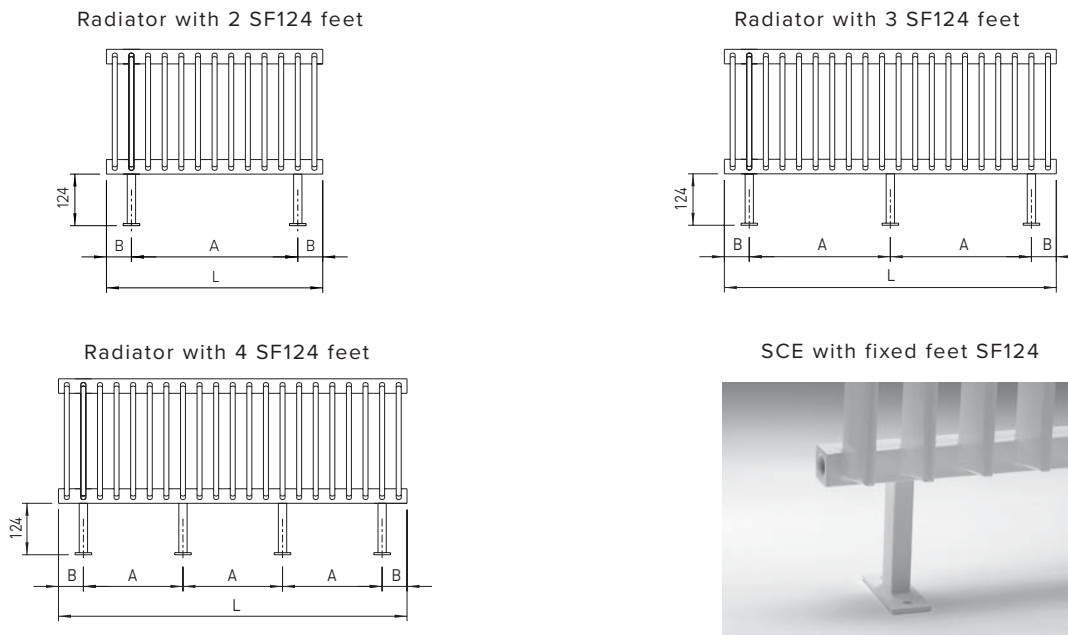

**Limitations in radiator height**

Radiator height, mm	Comments
400-600	-
700-3000	Top restraint by wall brackets is required (supplied)

**Distance B at different tapping combinations**

Element spacing, mm	Tapping combinations	
	ABCD	EE/FF and E/F
40	60	140
60	80	200

**POSITION AND NO. OF FEET**

No. of feet	Element spacing				
	A, mm	40 mm		60 mm	
		Elements	L, mm	Elements	L, mm
2	L - 2B	10-40	400-1600	8-26	400-1540
3	(L - 2B)/2	42-70	1640-2800	28-46	1660-2740
4	(L - 2B)/3	72-74	2840-2960	48-50	2860-2980

Feet will be welded under an element or between 2 elements. Therefore, distance A may vary. Distance B depends on tapping combination, see table above.

# OUTPUT

## SC SINGLE (SCE) TYPE 14 AND 16

Height, mm	W/m, 75°/65°/20°		W/metre 70°/40°/20°		W/metre 60°/30°/20°		Water content	Weight
	Element spacing, mm		Element spacing		Element spacing		litres/ element	kg/ element
	40	60	40	60	40	60		
400	753	590	526	410	307	239	0.30	1.1
500	908	707	613	476	358	278	0.35	1.4
600	1058	821	700	540	408	315	0.40	1.6
700	1208	933	785	606	458	354	0.45	1.8
900	1505	1158	958	736	559	429	0.55	2.3

## SC DOUBLE (SCD) TYPE 24 AND 26

Height, mm	W/m, 75°/65°/20°		W/metre 70°/40°/20°		W/metre 60°/30°/20°		Water content	Weight
	Element spacing, mm		Element spacing, mm		Element spacing, mm		liter/ element	kg/ element
	40	60	40	60	40	60		
400	1225	942	859	667	501	389	0.46	2.0
500	1483	1151	1007	785	588	458	0.55	2.4
600	1738	1355	1153	902	673	526	0.64	2.9
700	1990	1557	1298	1014	757	592	0.73	3.4
900	2488	1955	1578	1251	921	730	0.91	4.3

# OPTIONS

## ANGLED AND CURVED RADIATORS

**Description**

All SCE and SCD radiators can be supplied angled or curved. Tapping designations etc. follow the same principles as for straight radiators.

**Output calculation, angled:**

The exact no. of elements is determined by Hudevad taking ordered angle and element spacing into consideration.

**Output calculation, curved:**

When calculating the radiator output the length of the horizontal header and not the length of the wall is to be used.

**Installation**

Wall or floor mounted.  
Note: Unless otherwise specified, the radiator is supplied with bracket SB20 (SCE) or SB82 (SCD).

If alternative wall distance is required, please consult Hudevad.

### INTERNAL ANGLES

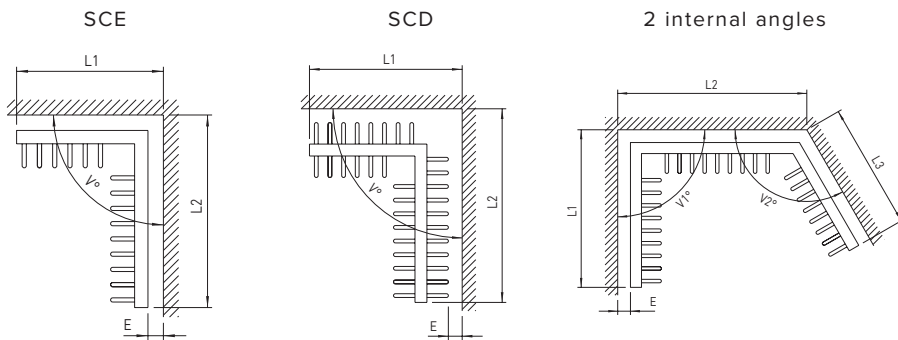

### EXTERNAL ANGLE

Drawing 11.1

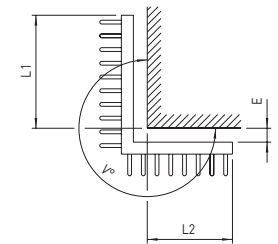

### INTERNAL CURVE

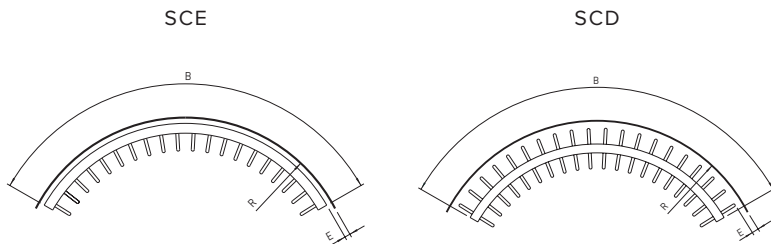

### EXTERNAL CURVE

Drawing 11.2

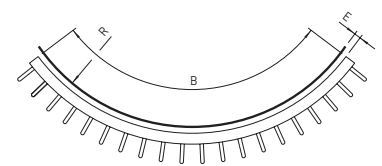

# ACCESSORIES

Drawing 12.1

Bracket SB20

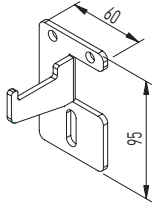

Bracket, profile

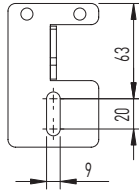

Spacer



SCE/type 14 and 16 uses bracket SB20 and SCD/type 24 and 26 uses bracket SB82

Note: Bracket SB82 has same backplate with longer outreach