

NOVUS



Datasheet

INDEX

Specification 2
 Description 3
 Tapping overview 4
 Dimensions 5
 Installation 7
 Output 7
 Accessories 8
 Availability Matrix 8

SPECIFICATION

HOW TO SPECIFY AN ITEM

Item number example 215049010

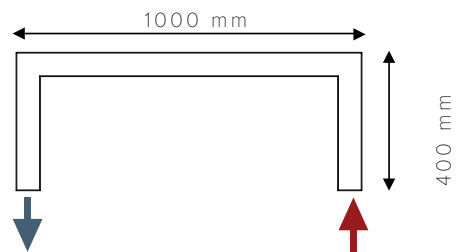
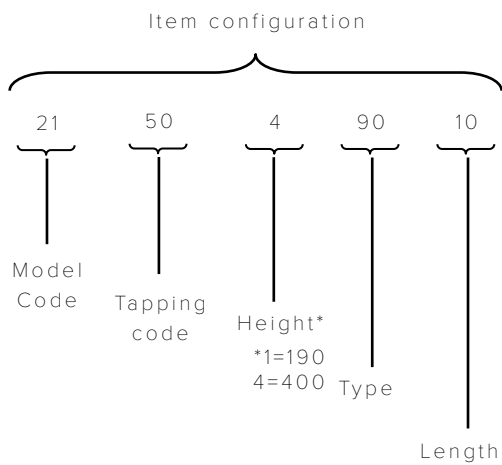

Note

Thermostat sensor head is not included in the product - should be ordered separately.

DESCRIPTION

The Hudevad Novus is with its clean lines and stylish expression well suited for many public environments such as offices, hospitals and shopping malls, but will also fit well in most contemporary homes. The slender design works well as protection against cold drafts when placed in front of large windows. The Hudevad Novus tall model, can also work as a bench and is suitable for sitting on.

Material	Panels: Profiled steel tubes 70x11x1,8 mm Distance between panels are 20 mm.
Test pressure	8 bar
Max. operating pressure	6 bar.
Max. operating temperature	110°C
Warranty	5 years
Surface treatment	Pre-treatment by degreasing and steel phosphating in accordance with DIN EN 442 and DIN EN 12476
Type	70, 90 and 110
Height	190 and 400 mm
Length	1000, 1100, 1200, 1400, 1500, 1600, 1800, 2000, 2200, 2200, 2400, 2500, 2600 and 2800 mm
Depth	Type 70: 197 mm Type 90: 259 mm Type 110: 321 mm
Connections	All tappings 1/2" standard (adapters available) All tappings are downward-facing inside the legs.
Installation	Floor mounted. Air vent and blind plug are included.
Colour	Powder coated in white RAL 9016, gloss 70 Option: Painted in other colours. Please see the Hudevad Radiator Design Colour Brochure at www.hudevad.com
Accessories	Leather cushions (L: 420 x W: 270 x H: 10 mm) in the colours cognac, dark brown and black

TAPPING OVERVIEW

Tapping code	Tapping type	Tapping possibilities
50	E/F, Right or left	
52	FF, Right	
53	EE, left	

Note

All tapings are downward-facing inside the legs.

Tapping code 52 and 53 - same side connection.

An internal divider plate is fitted inside the radiator to effectively control the flow of water. A small metal tap on the underside of the radiator indicates where the plate is fitted.

DIMENSIONS

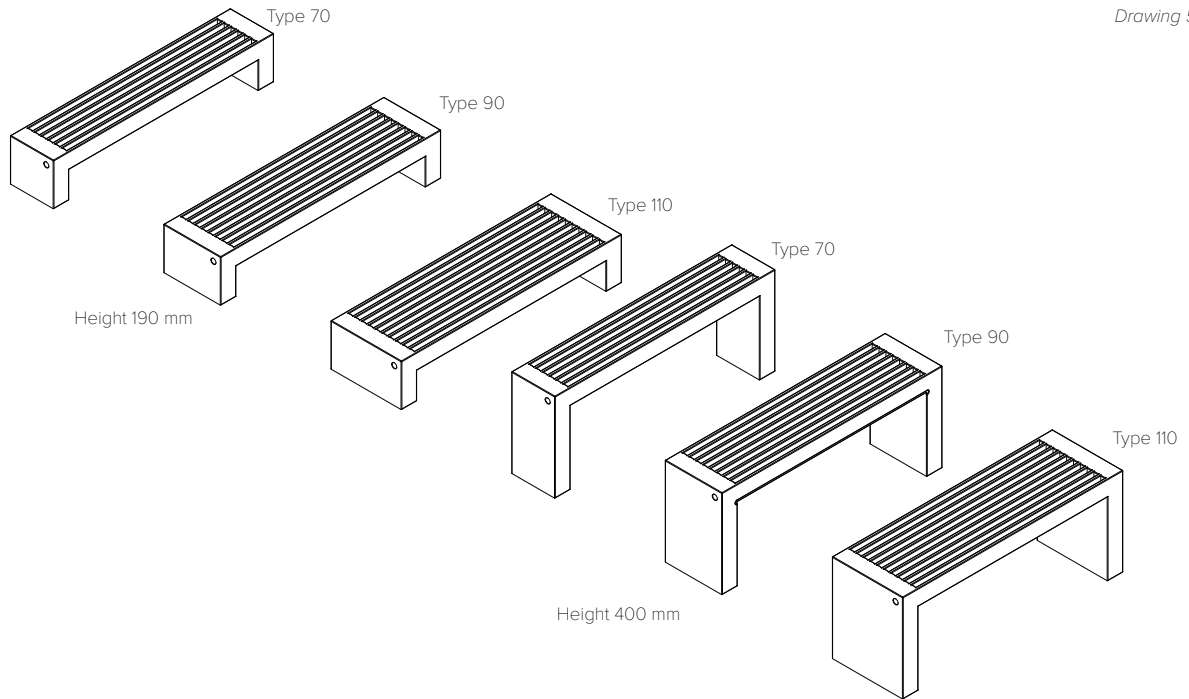

Drawing 5.1

HEIGHT AND LENGTH

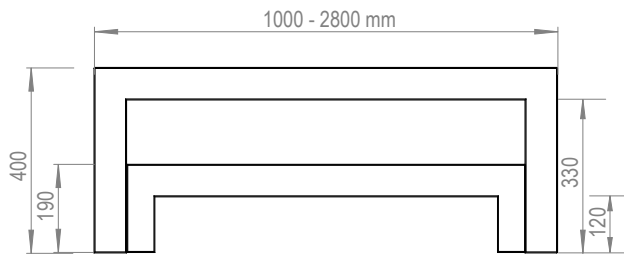

Drawing 5.2

DEPTH

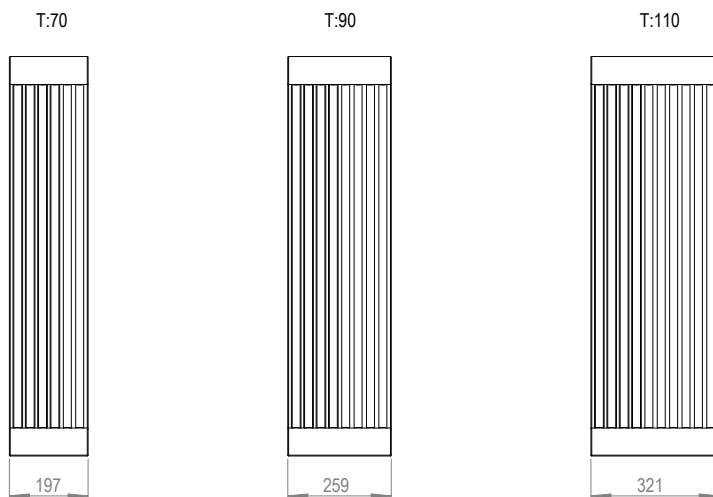

Drawing 5.3

BUILT-IN DIMENSION

Hudevad Novus are delivered with built in feet (standing consoles). The tappings are built-in to the underside of the convector, inside the consoles. There are three possible tapping configurations. Tapping Code 50 has one tapping in each console, and either one can be chosen for flow and return. Tapping codes 52 and 53 have both tappings in the right and the left console, respectively. Plate coverings with a cut-out for the thermostat are included. The flow pipe is always placed furthest in (closest to the wall), which allows for a concealed and protected placement of the thermostat, while still being accessible.

Tapping code 50 - all types

Drawing 6.1

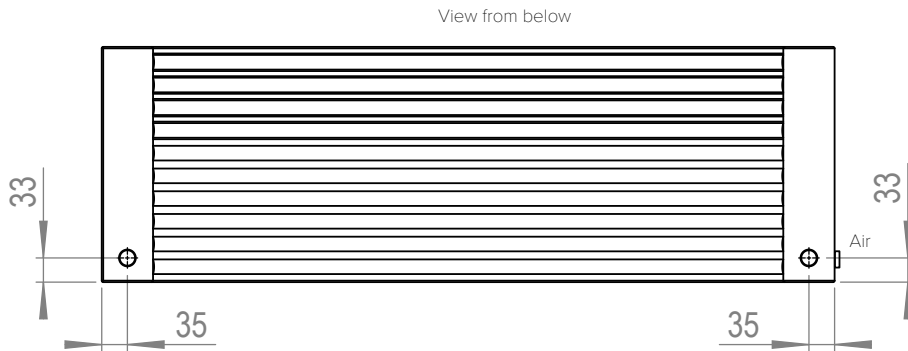

Drawing 6.2

Tapping code 52 - all types

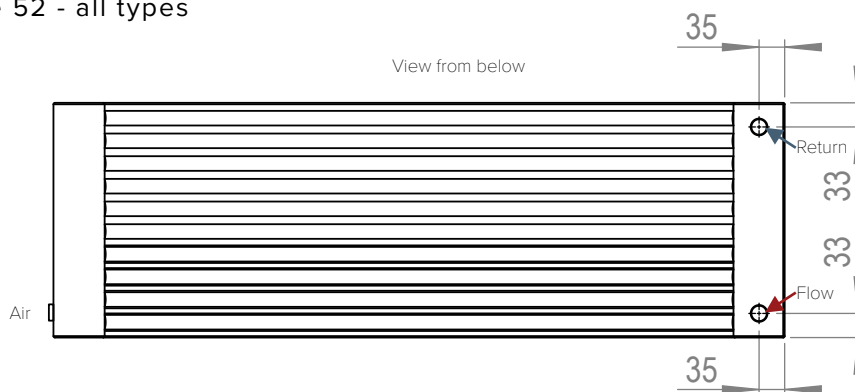

Tapping code 53 - all types

Drawing 6.3

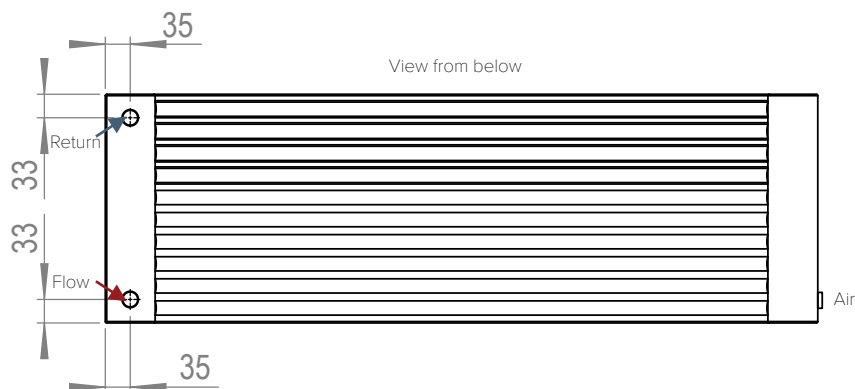

INSTALLATION

In order for the installation to be as discreet as possible, the pipes should come from the floor and be hidden in the floor bracket. It also houses a valve and thermostat which is thus well protected and at the same time regulates the power output for optimal indoor climate.

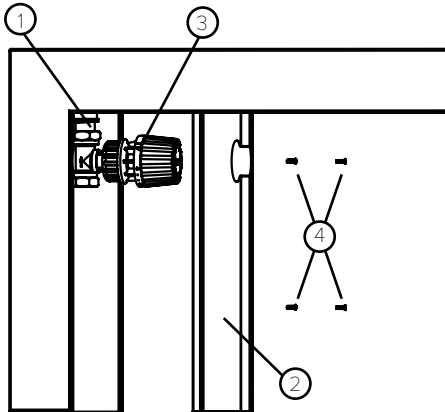

Hudevad Novus is adapted to fit straight radiator valves DN15 (1) for connection to the floor.

The side on which the connection is located is equipped with a cover plate (2) with a cut-out hole for the thermostat (3). The plate is fastened with the corresponding screws (4).

Shut-off valve can be mounted on the return connection. This will be completely hidden when the cover plate is mounted. The valve is always intended to be mounted in the connection closest to the wall. In this way, the valve and the thermostat will be well protected, but at the same time accessible.

OUTPUT

NOVUS

NOVUS 190 MM

Type	Height, mm	Output			Water content litres/ metre	Weight kg/ 1 m / 2 m / 3 m
		W/metre 75°/65°/20°	W/metre 70°/40°/20°	W/metre 60°/30°/20°		
70	190	586	356	218	3,75	21/37/53
90	190	745	453	277	4,8	26/46/67
110	190	922	561	344	5,9	27/50/72

NOVUS 400 MM

Type	Height, mm	Output			Water content litres/ metre	Weight kg/ 1 m / 2 m / 3 m
		W/metre 75°/65°/20°	W/metre 70°/40°/20°	W/metre 60°/30°/20°		
70	400	596	362	221	3,75	25/41/57
90	400	763	464	284	4,8	31/51/72
110	400	944	575	353	5,9	37/62/87

ACCESSORIES

Drawing 8.1

DANFOSS ACCESSORIES

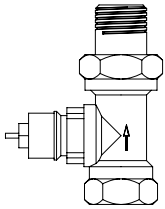

Danfoss straight running valve 40130014

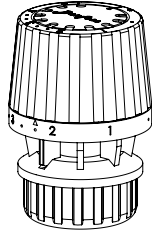

Danfoss thermostat RA 2990 40132610

ACCESSORIES

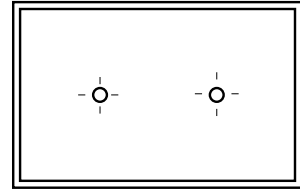

Leather cushion Cognac CUSHIONCOGNAC
 Leather cushion Dark Brown CUSHIONBROWN
 Leather cushion Black CUSHIONBLACK

Hudevad recommends use of Danfoss accessories when fitting the radiator.
 For further accessories please refer to the Hudevad Pricelist.

AVAILABILITY MATRIX

ALL TAPPING CODES

Lgth/ Type	Height 190 mm			Height 400 mm		
	70	90	110	70	90	110
1000	•	•	•	•	•	•
1100	•	•	•	•	•	•
1200	•	•	•	•	•	•
1400	•	•	•	•	•	•
1500	•	•	•	•	•	•
1600	•	•	•	•	•	•
1800	•	•	•	•	•	•
2000	•	•	•	•	•	•
2200	•	•	•	•	•	•
2400	•	•	•	•	•	•
2500	•	•	•	•	•	•
2600	•	•	•	•	•	•
2800	•	•	•	•	•	•
3000	•	•	•	•	•	•
4000	•	•	•	•	•	•